

**Compliance Guide
Rev.4.2, Edition 04/2018**

Chain-saws (combustion engine powered)

European Garden Machinery Federation
EGMF
Bd Reyers 80, 1030 Brussels, Belgium
secretariat@egmf.org
+32 2 206 68 66

1. Introduction

Chain-saw in conformity with EN ISO 11681-1:2011

Key

- 1) rear hand guard
- 2) rear handle
- 3) throttle trigger
- 4) throttle trigger lock-out
- 5) front handle
- 6) front hand guard
- 7) spiked bumper
- 8) guide-bar cover
- 9) guide-bar
- 10) saw chain
- 11) chain catcher

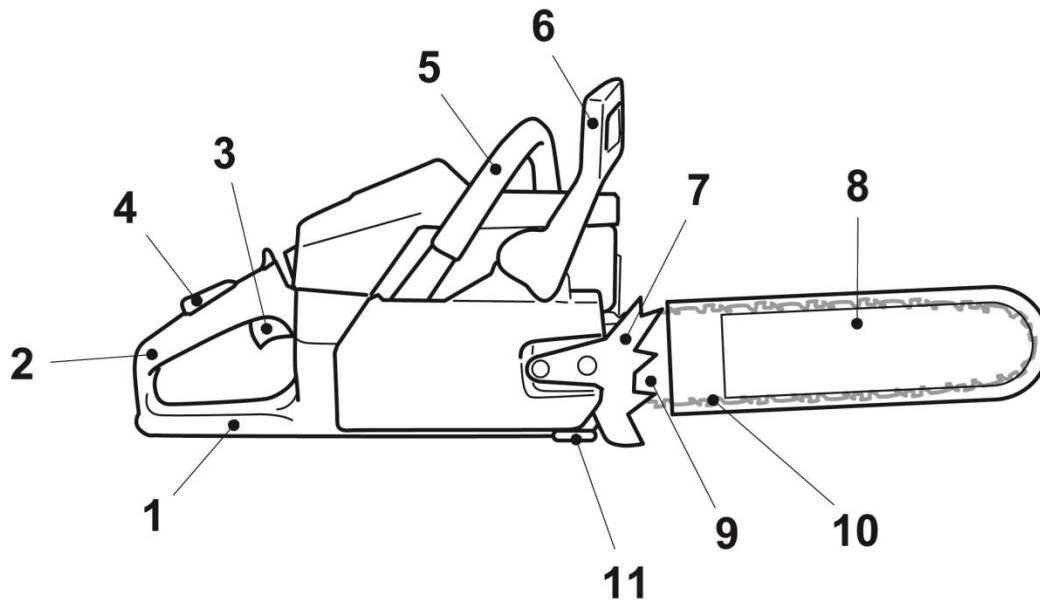

Note:

1. The standards indicated in this guide are the latest published versions.
2. The inspection of a product should be conducted using **ONLY** the standards as declared by the manufacturer in the D.o.C. delivered with the product.

Portable combustion-engine, hand-held chain-saw

1. Introduction

Main EU technical Directives and amendments & Regulations to be applied to chain-saws

Directive 97/68/EC repealed
01.01.2017

Regulation (EU) 2016/1628
Exhaust Emissions plus
supplementary acts

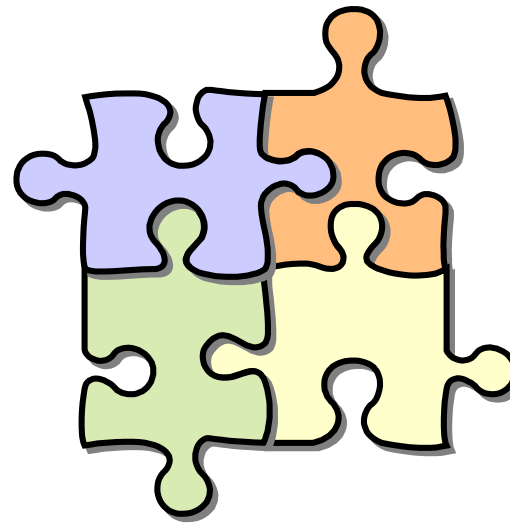

Directive 2006/42/EC
Machinery

Directive 2000/14/EC
(as amended)
Outdoor Noise

Directive 2014/30/EU
Electromagnetic Compatibility

1. Introduction

Is this chain-saw compliant with EU Directives?

- ✓ • This guide is intended for quick evaluation of chain-saw marking:
 - CE marking
 - Exhaust emission marking (EC type approval number)
 - Guaranteed sound power level

- ✓ • And documentation:
 - EU declaration of conformity
 - Instructions

- ✗ • This guide is not applicable for technical evaluations
- ✗ • This guide is not applicable to electric and tree service chain-saws
- ✗ • This guide contains extracts of relevant regulations and does not claim completeness of contents

2. Machinery Identification CE Marking

Machinery Directive 2006/42/EC

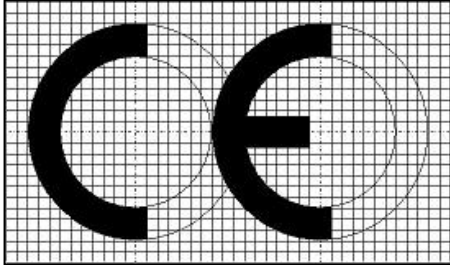

Illustration from 2006/42/EC

CE marking:

- The CE Conformity marking shall consist of the initials 'CE' as shown left;
- The CE marking shall be affixed to the machinery visibly, legibly and indelibly;
- The CE marking must include the minimum particulars (on the machine e.g. labelled, printed, embossed, etc.);
- The CE marking must be affixed in the immediate vicinity of the name of the manufacturer or his authorised representative, using the same technique.

Marking of machinery:

- Business name and address of the manufacturer or his authorised representative;
- Designation of the machinery (may be indicated by a code);
- Designation of series or type (may be indicated by a code and may be combined with the designation of the machinery);
- Serial number, if any;
- Year of construction/assembly.

3. Exhaust Emission Marking

According to the manufacturing date of the engine:

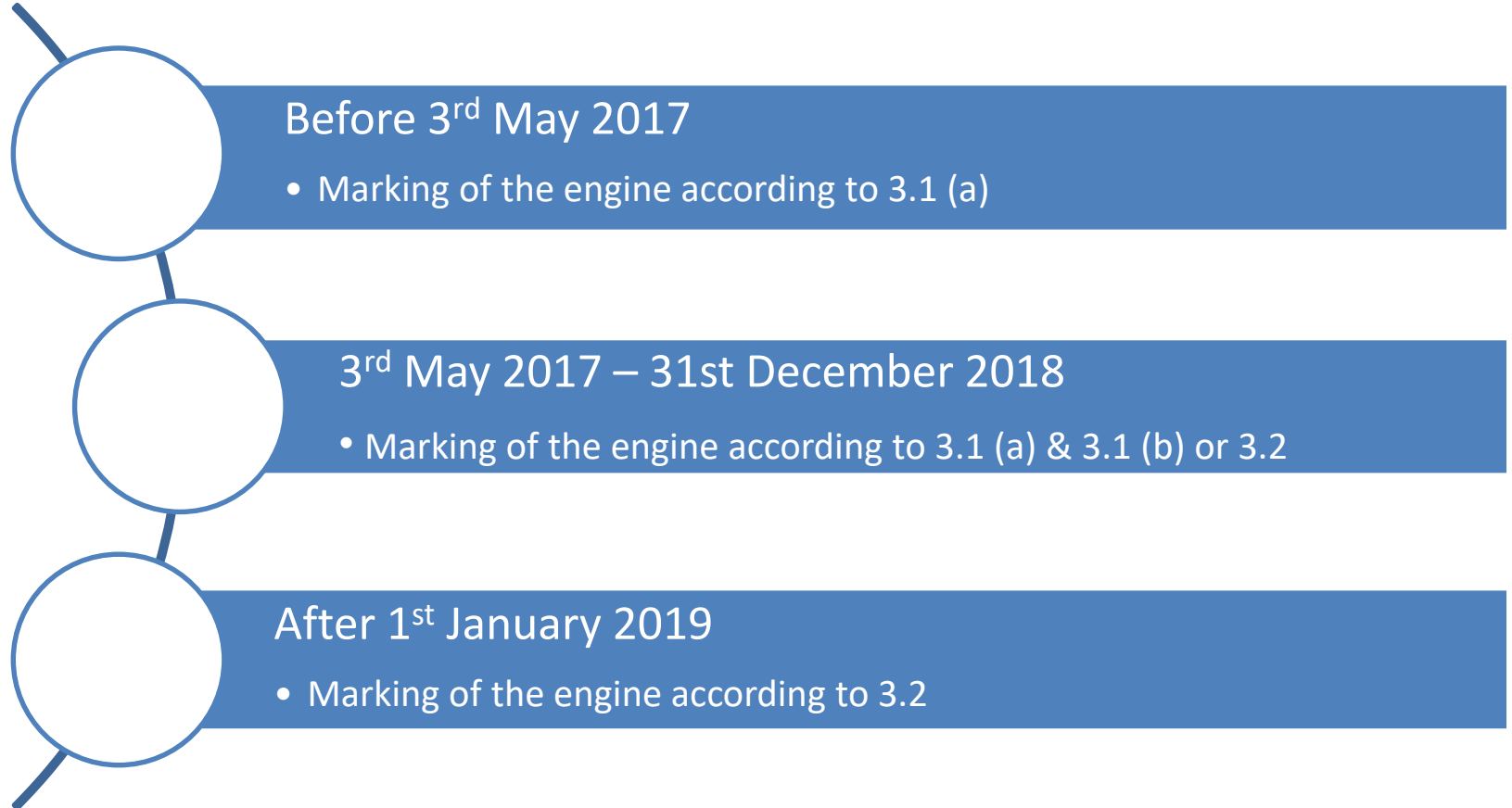

3.1(a) Engine Marking / EC Type Approval

- Until 31.12.18 engines that are in conformity with Directive 97/68/EC may continue to be produced and shall be marked with the EC Type Approval number according to the format below
- The EC type-approval number must be durable for the useful life of the engine and must be clearly legible and indelible
- The marking must be located so as to be readily visible to the average person after the engine has been completed with all the auxiliaries necessary for engine operation
- The number must consist of five sections separated by the ‘*’ character
- Example:

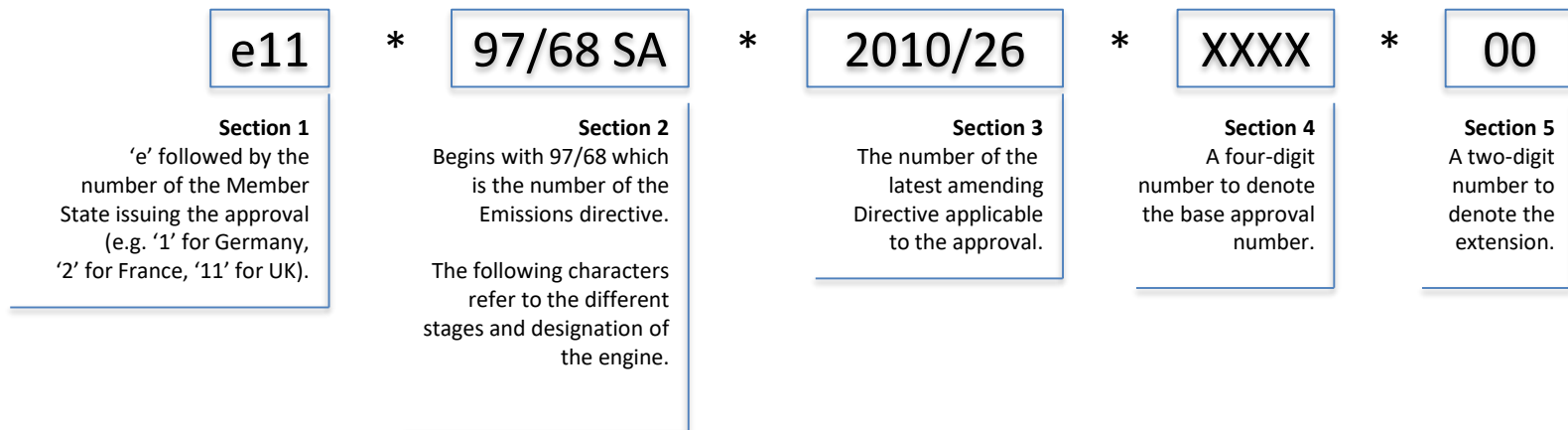

3.1(b) Transition Scheme – Reg. (EU) 2016/1628

- Transition scheme allows, during a transition period, the placing on the EU market of engines produced prior to the applicable Stage V placing on the market date. These engines are called transition engines.
- ‘transition period’ means the first 24 months following the dates set out in Annex III for the placing on the market of Stage V engines.
- The applicable dates are:
 - 31st December, 2018: End of production of Transition engines.
 - 30th June 2020: Last date of production for machines incorporating Transition engines.
 - 31st December, 2020: End of placing on the market of machines incorporating Transition engines.
- For a machine incorporating a transition engine, the machine production date in month and year (e.g. MM/YYYY) can be used instead of the engine production date.

3.2 Engine Marking / EC Engine Type Approval

- From 01.01.2019, engines shall be in conformity with Regulation (EU) 2016/1628 and be marked with the EC Type Approval number according to the format below, either by the certificate number (A) or by a simplified mark (B):
- Example for a hand-held petrol engine below 50 cc , the engine category is NRSh and sub-category is NRSh-v-1a so the coding is SHA1

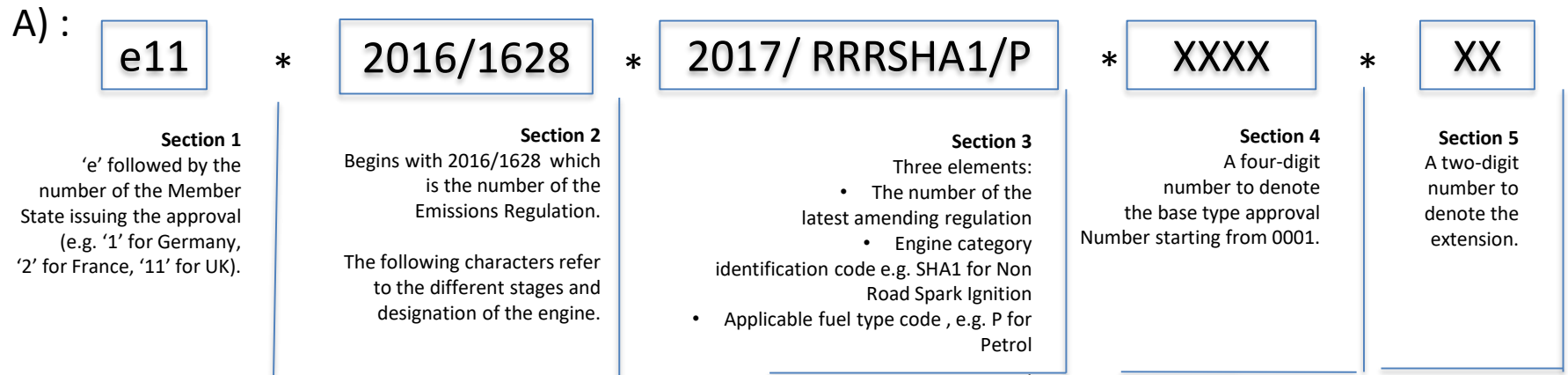

B) :

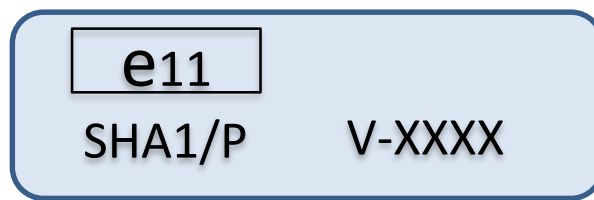

4. Marking / Outdoor Noise Label

Outdoor Noise Directive 2000/14/EC (as amended)

- The indication of the guaranteed sound power level must consist of
 - the single number of the guaranteed sound power in dB
 - the sign L_{WA} and
 - a pictogram taking the following form:

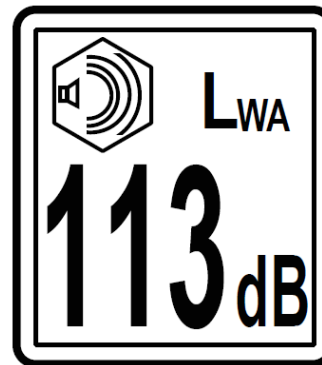

Example

- There are no noise limits for chain-saws but noise marking and declaration of the values in the instructions are required.

5. Documentation / Instructions

Machinery Directive 2006/42/EC

For clarification, consult the European Commission Guide to application of the Machinery Directive 2006/42/EC



- Machinery must be accompanied by instructions in the official Community language(s) of the Member State in which it is made available
- The instructions must contain at least the following information:
 - business name and full address of the manufacturer and of his authorised representative (if the manufacturer is not located in an EU Member State)
 - descriptions and explanations necessary for safe use, adjustment and maintenance operations that should be carried out by the user, and preventive maintenance measures that should be taken
 - a description of the intended use of the machinery (professional use and use by consumers)
 - warnings concerning ways in which the machinery must not be used that experience has shown might occur

6. Documentation / EU Declaration of Conformity

2006/42/EC, 2000/14/EC, 2014/30/EU

For clarification, consult the European Commission Guide to application of the Machinery Directive 2006/42/EC



The EU declaration of conformity (D.o.C.) must contain at least the following particulars:

- business name and full address of the manufacturer and, where appropriate, his authorised representative;
- name and address of the person authorised to compile the technical file, who must be established in the European Union;
- description and identification of the machinery including generic denomination, function, model, type, serial number and commercial name;
- a sentence expressly declaring that the machinery fulfils all the relevant provisions of this Directive and, where appropriate, a similar sentence declaring conformity with other Directives and/or relevant provisions with which the machinery complies;
- the name, address and notification number of the notified body which carried out the EC type examination in accordance with the Machinery Directive 2000/42/EC
- the number of the EC type examination certificate;
- the guaranteed and measured sound power level in accordance with the Outdoor Noise Directive 2000/14/EC;
- the place and date of the declaration of conformity;
- the identity and signature of the person empowered to draw up the declaration on behalf of the manufacturer or his authorised representative.

7. Warning Text or Pictograms on the Machine*

- Warning – See instructions!



Alternatives

- Wear a head, eye & hearing protection

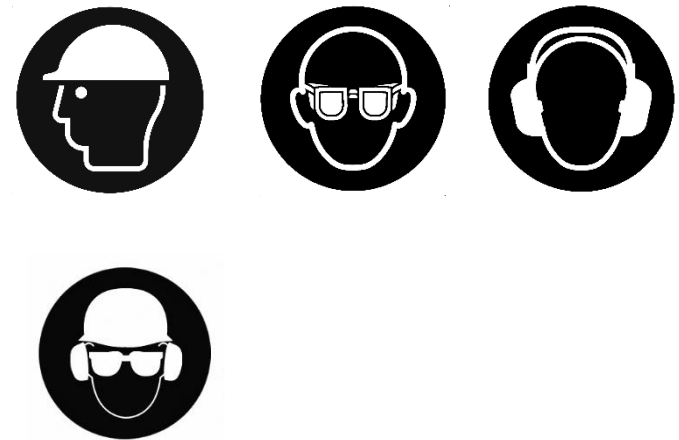

Alternative

- * If pictograms are used, they must be explained in the instructions
- * If text is used, it must be in the official language(s) of the country where the product is sold