

Compliance Guide
Rev.01, Edition 04/2018

Chain saws **(electric mains powered** **and battery powered)**

European Garden Machinery Federation
EGMF
Bd Reyers 80, 1030 Brussels, Belgium
secretariat@egmf.org
+32 2 206 68 66

1. Introduction

Electric chain saw in conformity with EN 60745-1:2009/A11:2010 & EN 60745-2-13:2009/A1:2010

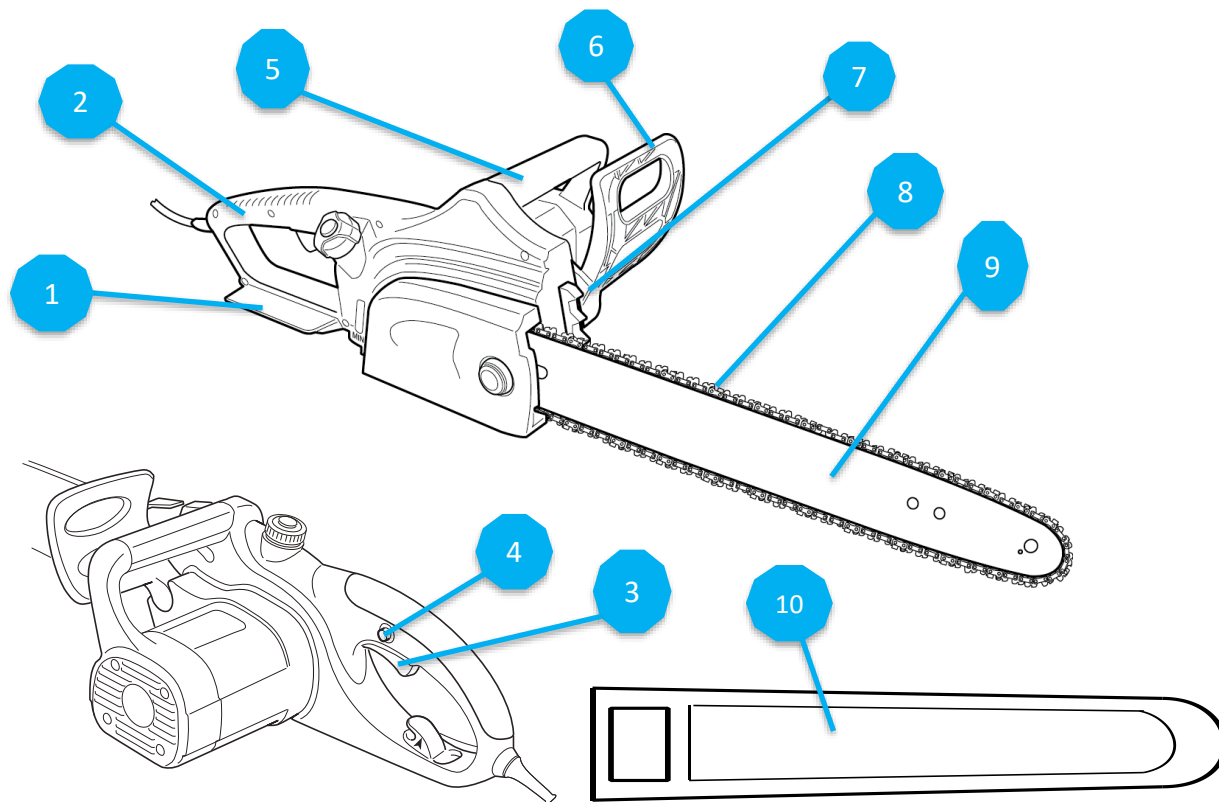

Portable, electrically powered, hand-held chain saw

Key

- 1) rear hand guard
- 2) rear handle
- 3) power switch
- 4) switch lock-off
- 5) front handle
- 6) front hand guard
- 7) spiked bumper
- 8) saw chain
- 9) guide bar
- 10) guide bar cover

Note:

1. The standards indicated in this guide are the latest published versions.
2. The inspection of a product should be conducted using **ONLY** the standards as declared by the manufacturer in the D.o.C. delivered with the product.

1. Introduction

Main EU technical Directives to be applied to electric chain saws

Directive 2006/42/EC
Machinery

Directive 2011/65/EU
RoHS
(as amended)
Restriction of Hazardous
Substances

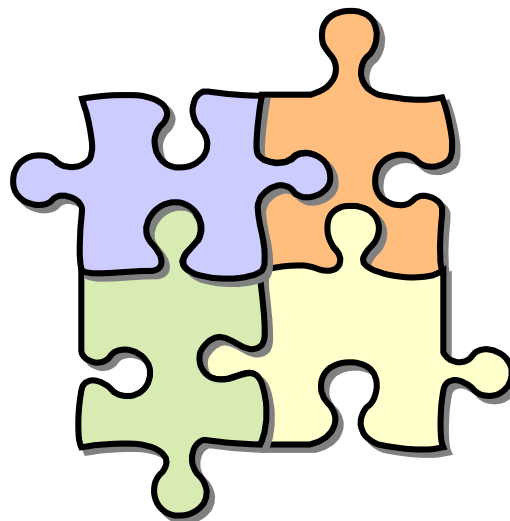

Directive 2000/14/EC (as amended)
Outdoor Noise

Directive 2012/19/EU
WEEE
Waste Electrical &
Electronic Equipment

Directive 2014/30/EU
Electromagnetic Compatibility

1. Introduction

Is this chain saw compliant with EU Directives?

- ✓ • This guide is intended for quick evaluation of electric chain saw marking:
 - CE marking
 - Guaranteed sound power level

- ✓ • Documentation:
 - EU declaration of conformity (D.o.C.)
 - Instructions

- ✗ • This guide is not applicable for technical evaluations
- ✗ • This guide is not applicable to battery powered chain saws for tree service
- ✗ • This guide is not applicable to combustion engine driven chain saws
- ✗ • This guide contains extracts of relevant regulations and does not claim completeness of contents

2. Machinery Identification CE Marking

Machinery Directive 2006/42/EC

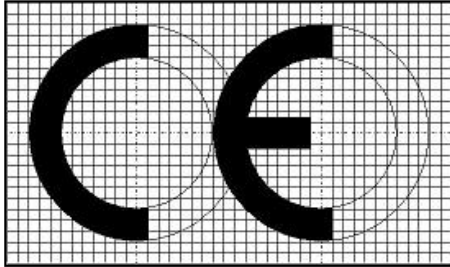

Illustration from 2006/42/EC

CE marking:



- The CE Conformity marking shall consist of the initials 'CE' as shown left;
- The CE marking shall be affixed to the machinery visibly, legibly and indelibly;
- The CE marking must include the minimum particulars (on the machine e.g. labelled, printed, embossed, etc.);
- The CE marking must be affixed in the immediate vicinity of the name of the manufacturer or his authorised representative, using the same technique.

Marking of machinery:

- Business name and address of the manufacturer or his authorised representative;
- Designation of the machinery (may be indicated by a code);
- Designation of series or type (may be indicated by a code and may be combined with the designation of the machinery);
- Serial number, if any;
- Year of construction/assembly.

3. Marking requirements

From EN 60745-2-13:2009/A1:2010

- For mains powered chain saws:
 - Rated voltage or rated voltage range in Volts e.g. 230 V or 230-240 V
 - Nature of supply, e.g. 50 Hz or a.c. or ~
 - Symbol for class II machines 
 - Rated power input in Watts or rated current in Amperes
- For battery powered chain saws:
 - Rated voltage in Volts e.g. 18 V
 - Nature of supply, d.c. or 

From the WEEE Directive 2012/19/EU

- Waste Electrical & Electronic Equipment.



4. Marking / Outdoor Noise Label

Outdoor Noise Directive 2000/14/EC (as amended)

- The indication of the guaranteed sound power level must consist of:
 - the single number of the guaranteed sound power in dB
 - the sign L_{WA} and
 - a pictogram taking the following form:

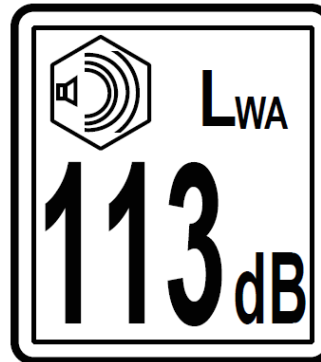

Example

- There are no noise limits for electric chain saws but the noise marking and the declaration of the values in the instructions are required.

5. Documentation / Instructions

Machinery Directive 2006/42/EC

For clarification, consult the European Commission Guide to application of the Machinery Directive 2006/42/EC



- Machinery must be accompanied by instructions in the official Community language(s) of the Member State in which it is made available
- The instructions must contain at least the following information:
 - business name and full address of the manufacturer and of his authorised representative (if the manufacturer is not located in an EU Member State)
 - descriptions and explanations necessary for safe use, adjustment and maintenance operations that should be carried out by the user, and preventive maintenance measures that should be taken
 - a description of the intended use of the machinery (professional use and use by consumers)
 - warnings concerning ways in which the machinery must not be used that experience has shown might occur

6. Documentation / EU Declaration of Conformity

2006/42/EC, 2000/14/EC, 2014/30/EU

For clarification, consult the European Commission Guide to application of the Machinery Directive 2006/42/EC



The EU declaration of conformity (D.o.C.) must contain at least the following particulars:

- business name and full address of the manufacturer and, where appropriate, his authorised representative;
- name and address of the person authorised to compile the technical file, who must be established in the European Union;
- description and identification of the machinery including generic denomination, function, model, type, serial number and commercial name;
- a sentence expressly declaring that the machinery fulfils all the relevant provisions of this Directive and, where appropriate, a similar sentence declaring conformity with other Directives and/or relevant provisions with which the machinery complies;
- the name, address and notification number of the notified body which carried out the EC type examination in accordance with the Machinery Directive 2006/42/EC
- the number of the EC type examination certificate;
- the guaranteed and measured sound power level in accordance with the Outdoor Noise Directive 2000/14/EC;
- the place and date of the declaration of conformity;
- the identity and signature of the person empowered to draw up the declaration on behalf of the manufacturer or his authorised representative.

7. Warning text or pictograms on the machine*

- **WARNING – To reduce the risk of injury, user must read instructions or**



- **Wear eye protection or**



or



- **Wear ear protection or (if applicable)**



or



or



- **Do not expose to rain or**



(if applicable)

- **Remove plug from the mains immediately if the cable is damaged or cut (if applicable)**

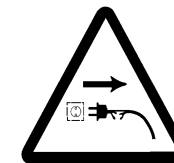

* If pictograms are used, they must be explained in the instructions

* If text is used, it must be in the official language(s) of the country where the product is sold