

**Compliance Guide  
Rev.1.1, Edition 04/2018**

# **Garden Shredders / Chippers hand fed (combustion engine powered)**

European Garden Machinery Federation  
EGMF  
Bd Reyers 80, 1030 Brussels, Belgium  
[secretariat@egmf.org](mailto:secretariat@egmf.org)  
+32 2 206 68 66

# 1. Introduction

## Shredder/Chipper in conformity with EN 13683:2003+A2:2011 /AC:2013

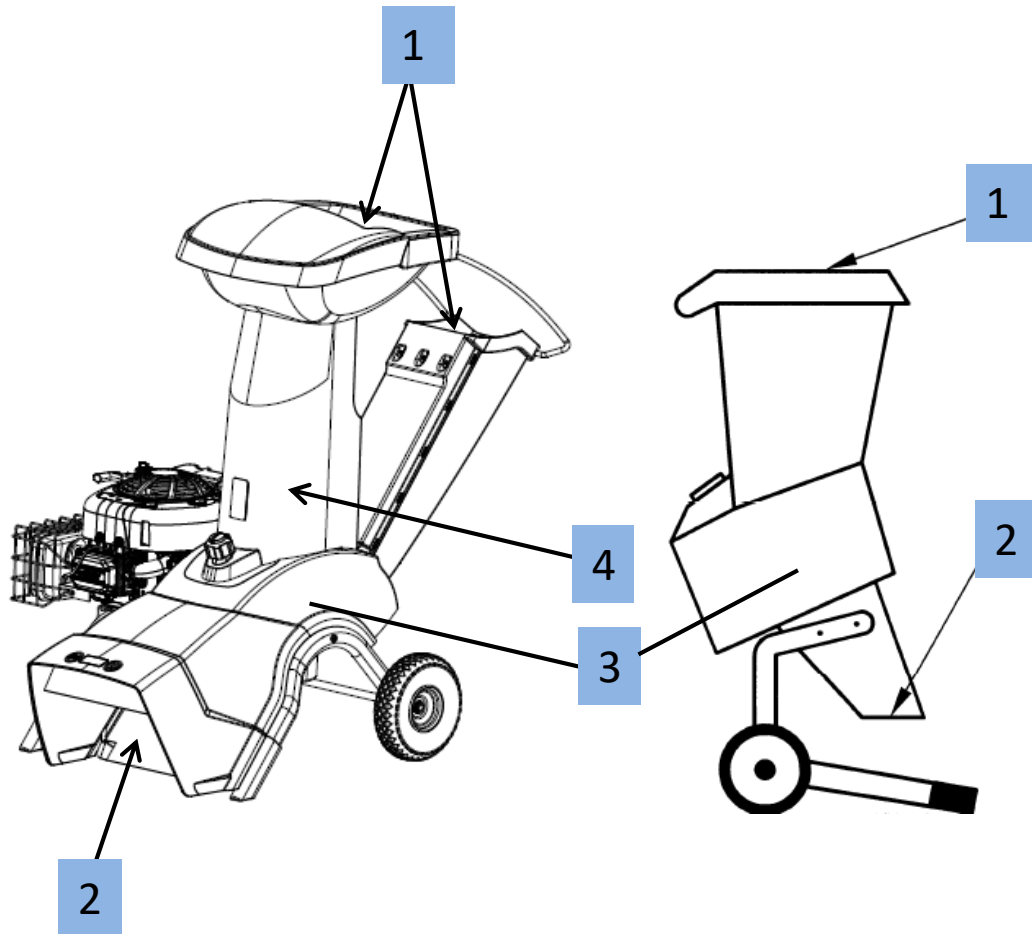

### Key:

- 1 Feed intake opening  
(Feed safety opening)
- 2 Discharge chute
- 3 Cutting means
- 4 Interlocked guard

### Note:

- 1. The standards indicated in this guide are the latest published versions.
- 2. The inspection of a product should be conducted using **ONLY** the standards as declared by the manufacturer in the D.o.C. delivered with the product.

# 1. Introduction

**Main EU technical Directives/ Regulations to be applied to combustion engine powered shredders**

**Directive 97/68/EC** repealed  
01.01.2017

**Regulation (EU) 2016/1628**  
Exhaust Emissions plus  
supplementary acts

**Directive 2006/42/EC**  
Machinery

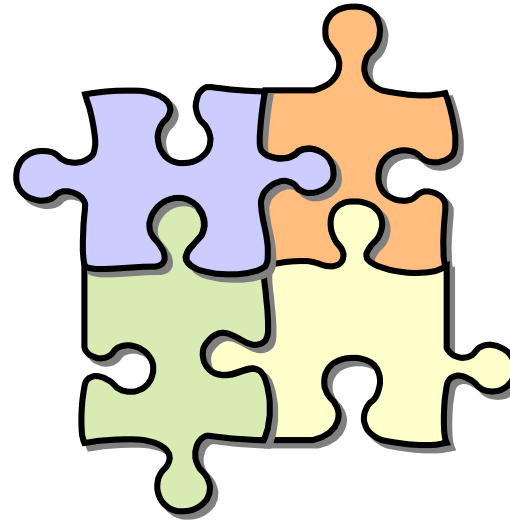

**Directive 2000/14/EC**  
(as amended)  
Outdoor Noise

**Directive 2014/30/EU**  
Electromagnetic Compatibility

# 1. Introduction

## Is this shredder/chipper compliant with EU Directives?

- ✓ • This guide is intended for quick evaluation of integrally (combustion engine) powered shredder / chipper marking:
  - CE marking
  - Engine exhaust emission marking (EC type approval number)
  - Guaranteed sound power level
  
- ✓ • Documentation:
  - EU Declaration of Conformity (D.o.C.)
  - Instructions
  
- ✗ • This guide is not applicable for technical evaluations
- ✗ • This guide is not applicable to mains operated (electric) shredders / chippers
  
- ✗ • This guide contains extracts of relevant regulations and does not claim completeness of contents

# 2. Machinery Identification CE Marking

## Machinery Directive 2006/42/EC

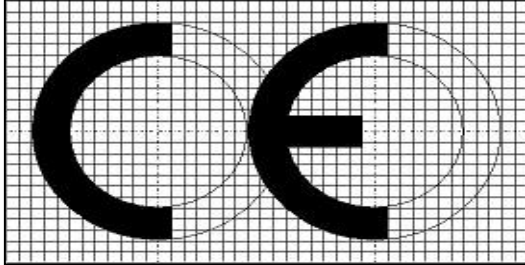

Illustration from 2006/42/EC

### CE marking:

The CE Conformity marking shall consist of the initials 'CE' as shown left;

- The CE marking shall be affixed to the machinery visibly, legibly and indelibly;
- The CE marking must include the minimum particulars (on the machine e.g. labelled, printed, embossed, etc.);
- The CE marking must be affixed in the immediate vicinity of the name of the manufacturer or his authorised representative, using the same technique.

### Marking of machinery:

- Business name and address of the manufacturer or his authorised representative;
- Designation of the machinery (may be indicated by a code);
- Designation of series or type (may be indicated by a code and may be combined with the designation of the machinery);
- Serial number, if any;
- Year of construction/assembly
- Nominal power in kW (if over 20 kW)
- Mass in kg (if over 25 kg)

# 3. Exhaust Emission Marking

According to the manufacturing date of the engine:

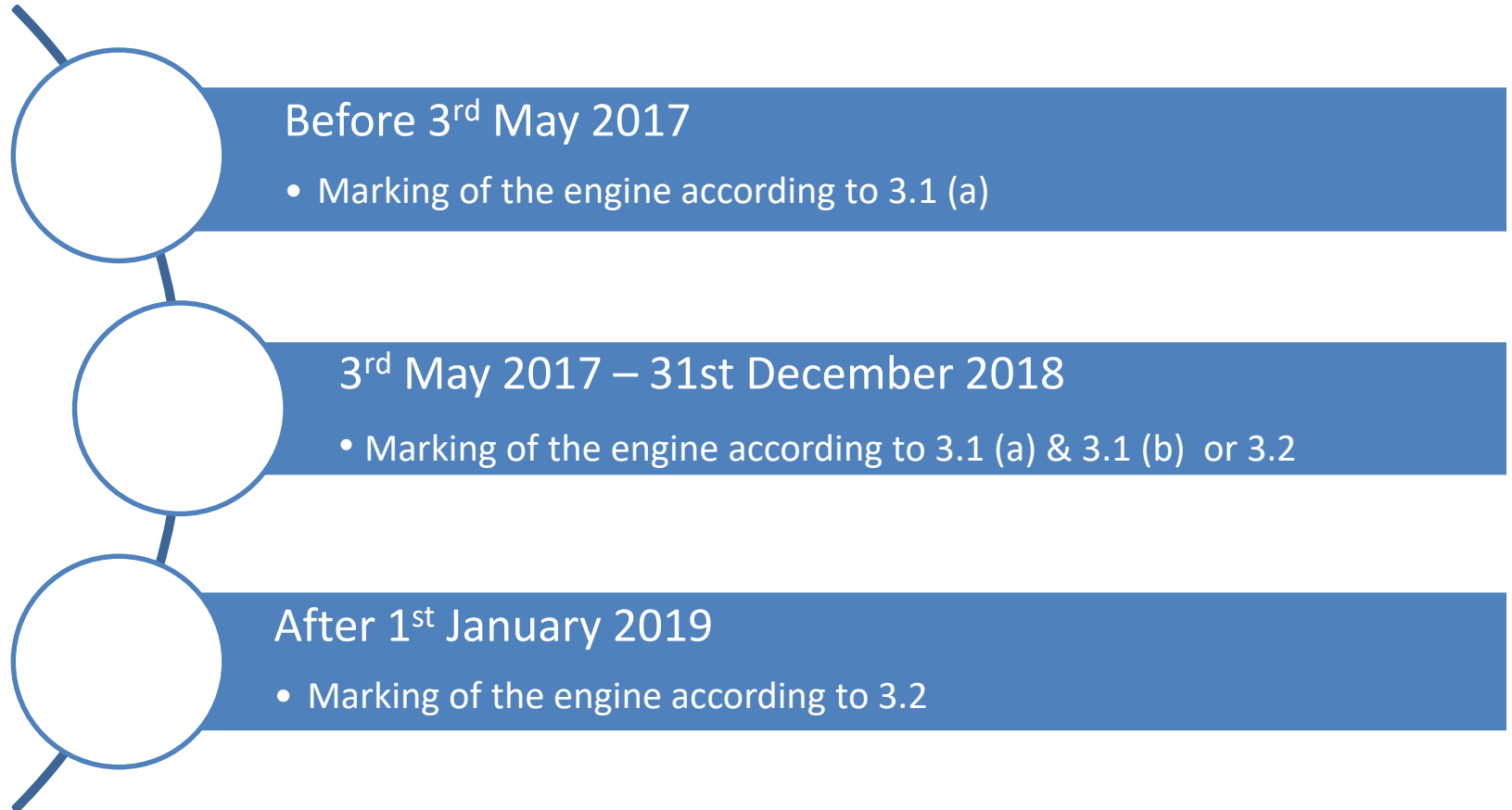

# 3.1(a) Engine Marking / EC Type Approval

- Until 31.12.18 engines that are in conformity with Directive 97/68/EC may continue to be produced and shall be marked with the EC Type Approval number according to the format below
- The EC type-approval number must be durable for the useful life of the engine and must be clearly legible and indelible
- The marking must be located so as to be readily visible to the average person after the engine has been completed with all the auxiliaries necessary for engine operation
- The number must consist of five sections separated by the '\*' character

Example: **e11** \* **97/68 SA** \* **2010/26** \* **XXXX** \* **00**

<p><b>Section 1</b> 'e' followed by the number of the Member State issuing the approval (e.g. '1' for Germany, '2' for France, '11' for UK).</p>	<p><b>Section 2</b> Begins with 97/68 which is the number of the Emissions directive.  The following characters refer to the different stages and designation of the engine.</p>	<p><b>Section 3</b> The number of the latest amending Directive applicable to the approval.</p>	<p><b>Section 4</b> A four-digit number to denote the base approval number.</p>	<p><b>Section 5</b> A two-digit number to denote the extension.</p>
--	--	---	---	---

## 3.1(b) Transition Scheme – Reg. (EU) 2016/1628

- Transition scheme allows, during a transition period, the placing on the EU market of engines produced prior to the applicable Stage V placing on the market date. These engines are called transition engines.
- ‘transition period’ means the first 24 months following the dates set out in Annex III for the placing on the market of Stage V engines.
- The applicable dates are:
  - 31st December, 2018: End of production of Transition engines.
  - 30th June 2020: Last date of production for machines incorporating Transition engines.
  - 31st December, 2020: End of placing on the market of machines incorporating Transition engines.
- For the transition engine, marking shall additionally include the engine production date (month and year).(e.g. MM/YYYY), this marking may be a separate mark.



## 3.2 Engine Marking / EC Type Approval

- From 01.01.2019 engines shall be in conformity with Regulation (EU) 2016/1628 and be marked with the EC Type Approval number according to the format below, either by the certificate number A) or by a simplified mark B):
- Example for a petrol engine with variable rpm < 3600 rpm and  $\geq 225$  cc , the engine category is NRS and sub-category is NRS-vi-1b so the coding is SYB1.

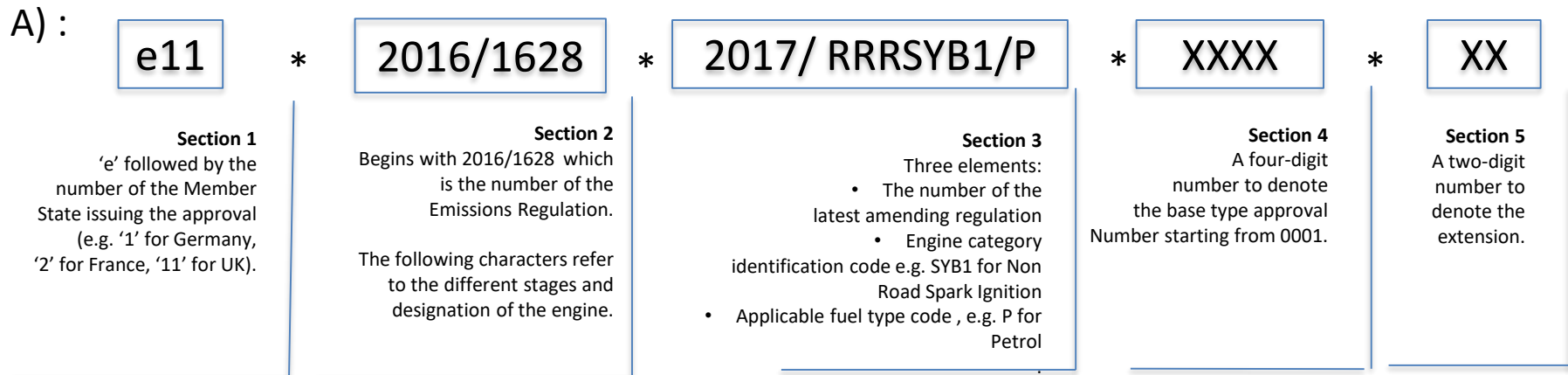

B) :

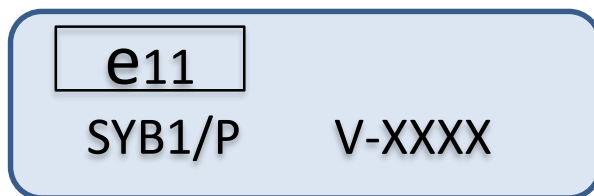

## 4. Marking / Outdoor Noise Label

### Outdoor Noise Directive 2000/14/EC (as amended)

- The indication of the guaranteed sound power level must consist of:
  - the single number of the guaranteed sound power in dB
  - the sign  $L_{WA}$  and
  - a pictogram taking the following form:

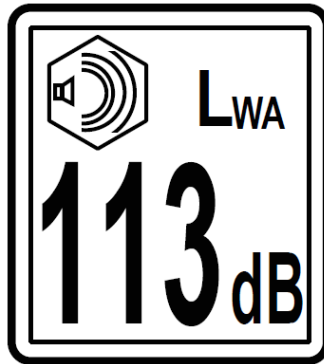

Example

- There is no noise limit for integrally powered shredders / chippers but noise marking and declaration of the values in the instructions are required.

# 5. Documentation / Instructions

## Machinery Directive 2006/42/EC

For clarification, consult the European Commission Guide to application of the Machinery Directive 2006/42/EC



- Machinery must be accompanied by instructions in the official Community language(s) of the Member State in which it is made available
- The instructions must contain at least the following information:
  - business name and full address of the manufacturer and of his authorised representative (if the manufacturer is not located in an EU Member State)
  - descriptions and explanations necessary for safe use, adjustment and maintenance operations that should be carried out by the user, and preventive maintenance measures that should be taken
  - a description of the intended use of the machinery (professional use and use by consumers)
  - warnings concerning ways in which the machinery must not be used that experience has shown might occur

# 6. Documentation / EU Declaration of Conformity

**2006/42/EC, 2000/14/EC, 2014/30/EU**

For clarification, consult the European Commission Guide to application of the Machinery Directive 2006/42/EC



The EU declaration of conformity (D.o.C.) must contain at least the following particulars:

- business name and full address of the manufacturer and, where appropriate, his authorised representative;
- name and address of the person authorised to compile the technical file, who must be established in the European Union;
- description and identification of the machinery including generic denomination, function, model, type, serial number and commercial name;
- a sentence expressly declaring that the machinery fulfils all the relevant provisions of this Directive and, where appropriate, a similar sentence declaring conformity with other Directives and/or relevant provisions with which the machinery complies;
- the guaranteed and measured sound power level in accordance with the Outdoor Noise Directive 2000/14/EC;
- the place and date of the declaration of conformity;
- the identity and signature of the person empowered to draw up the declaration on behalf of the manufacturer or his authorised representative.

# 7. Warning Text or Pictograms on the Machine\*

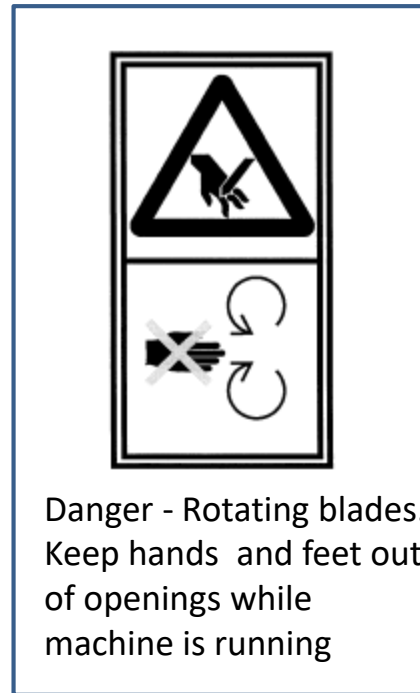
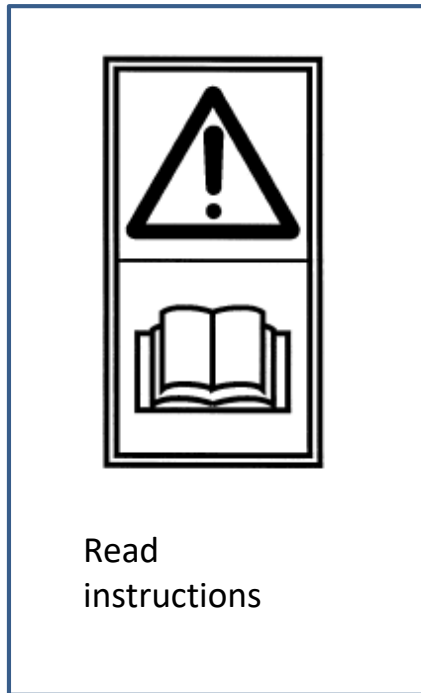

- \* If pictograms are used, they must be explained in the instructions
- \* If text is used, it must be in the official language(s) of the country where the product is sold