

Compliance Guide
Rev.2.1, Edition 04/2018

Lawnmowers, pedestrian controlled (combustion engine powered)

European Garden Machinery Federation

EGMF

Bd Reyers 80, 1030 Brussels, Belgium

secretariat@egmf.org

+32 2 206 68 66

This guide is intended to help market surveillance authorities with the checking of conformity of pedestrian controlled lawnmowers in the European Union. It should only be taken as suggestions or observations for consideration.

1. Introduction

Lawnmowers in conformity with EN ISO 5395-1:2013 & EN ISO 5395-2:2013/A2:2017

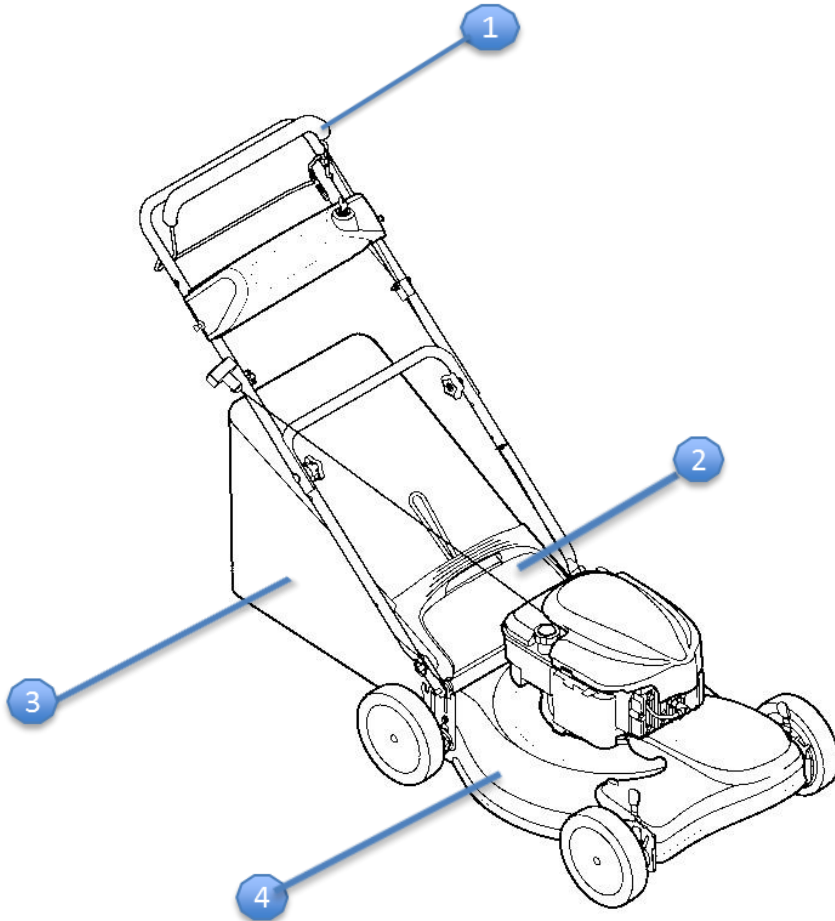

Key

- 1) Operator Presence Control
- 2) Self closing rear discharge guard
- 3) Grass catcher
- 4) Cutting means enclosure

Note:

1. The standards indicated in this guide are the latest published versions.
2. The inspection of a product should be conducted using **ONLY** the standards as declared by the manufacturer in the D.o.C. delivered with the product.

Rear collect combustion engine powered pedestrian controlled lawnmower

1. Introduction

Main EU technical Directives/ Regulations to be applied to combustion engine powered pedestrian controlled lawnmowers

Directive 97/68/EC repealed
01.01.2017

Regulation (EU) 2016/1628
Exhaust Emissions plus
supplementary acts

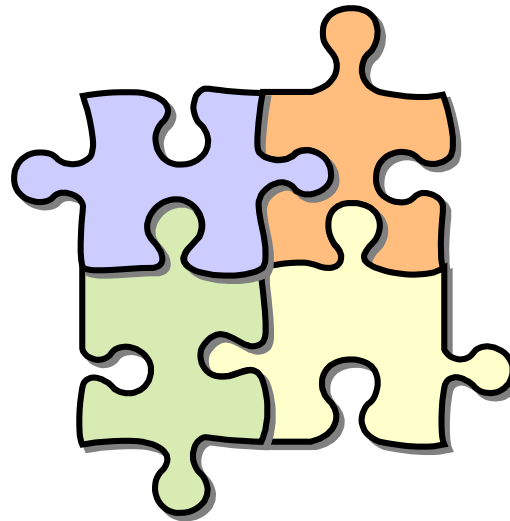

Directive 2006/42/EC
Machinery

Directive 2000/14/EC
(as amended)
Outdoor Noise

Directive 2014/30/EU
Electromagnetic Compatibility

1. Introduction

Is this lawnmower compliant with EU Directives?

- ✓ • This guide is intended for quick evaluation of combustion engine powered pedestrian controlled lawnmower marking:
 - CE marking
 - Engine exhaust emission marking
 - Guaranteed sound power level

- ✓ • And documentation:
 - EU declaration of conformity
 - Instructions

- ✗ • This guide is not applicable for technical evaluations
- ✗ • This guide is not applicable to pedestrian controlled electric lawnmowers
- ✗ • This guide contains extracts of relevant regulations and does not claim completeness of contents

2. Machinery Identification CE Marking

Machinery Directive 2006/42/EC

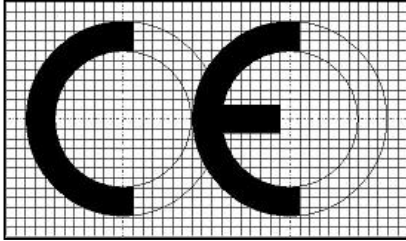

Illustration from 2006/42/EC

CE marking:

- The CE Conformity marking shall consist of the initials 'CE' as shown left;
- The CE marking shall be affixed to the machinery visibly, legibly and indelibly;
- The CE marking must include the minimum particulars (on the machine e.g. labelled, printed, embossed, etc.);
- The CE marking must be affixed in the immediate vicinity of the name of the manufacturer or his authorised representative, using the same technique.

Marking of machinery:

- Business name and address of the manufacturer or his authorised representative;
- Designation of the machinery (may be indicated by a code);
- Designation of series or type (may be indicated by a code and may be combined with the designation of the machinery);
- Serial number, if any;
- Year of construction/assembly;
- Nominal rated power, in kW;
- Mass of the machine, in kg.

3. Exhaust Emission Marking

According to the manufacturing date of the engine:

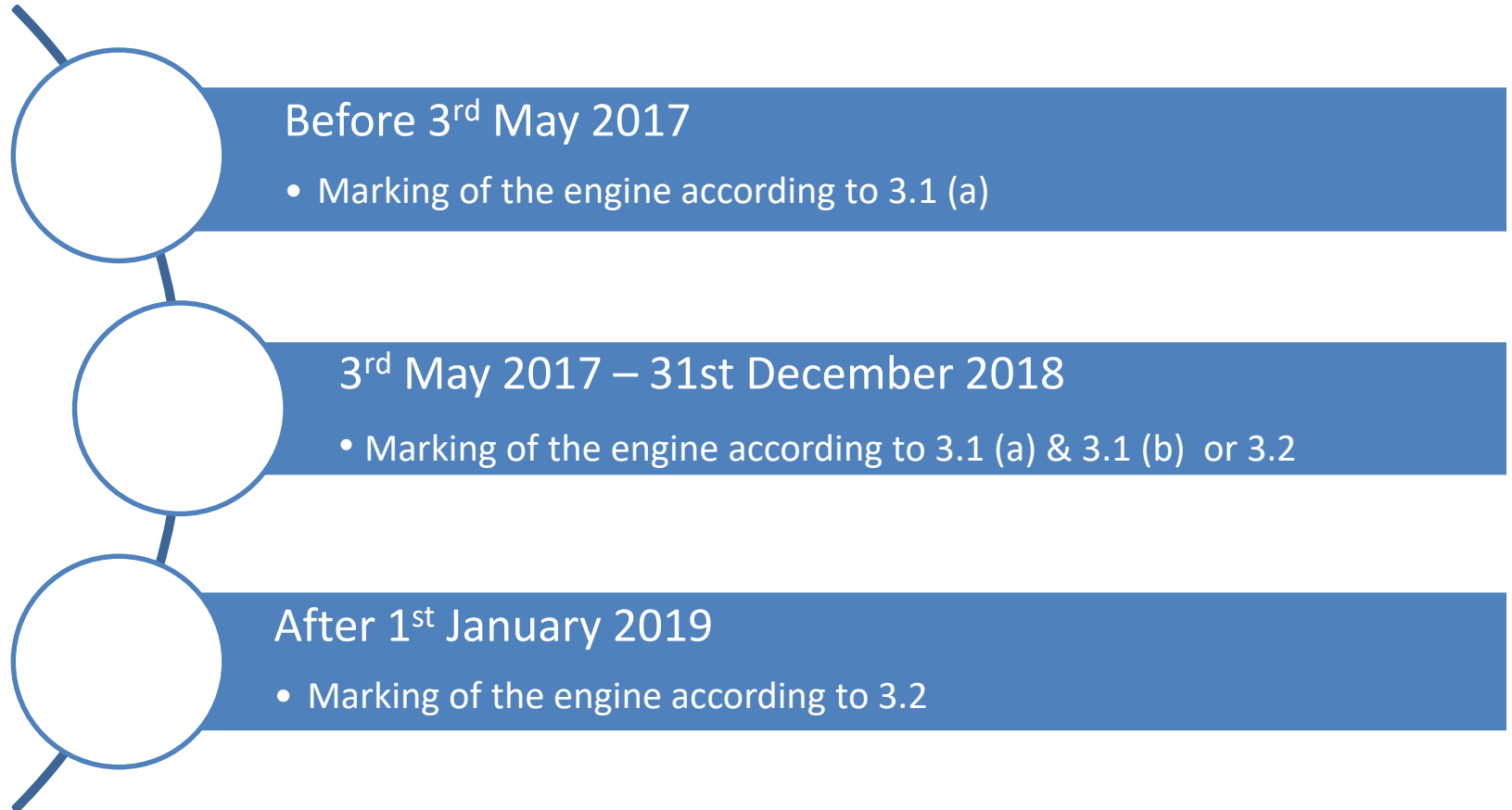

3.1(a) Engine Marking / EC Type Approval

- Until 31.12.18 engines that are in conformity with Directive 97/68/EC may continue to be produced and shall be marked with the EC Type Approval number according to the format below
- The EC type-approval number must be durable for the useful life of the engine and must be clearly legible and indelible
- The marking must be located so as to be readily visible to the average person after the engine has been completed with all the auxiliaries necessary for engine operation
- The number must consist of five sections separated by the '*' character

• Example:

e11

Section 1
'e' followed by the number of the Member State issuing the approval (e.g. '1' for Germany, '2' for France, '11' for UK).

*

97/68 SA

Section 2
Begins with 97/68 which is the number of the Emissions directive.

The following characters refer to the different stages and designation of the engine.

*

2010/26

Section 3
The number of the latest amending Directive applicable to the approval.

*

XXXX

Section 4
A four-digit number to denote the base approval number.

*

00

Section 5
A two-digit number to denote the extension.

3.1(b) Transition Scheme – Reg. (EU) 2016/1628

- Transition scheme allows, during a transition period, the placing on the EU market of engines produced prior to the applicable Stage V placing on the market date. These engines are called transition engines.
- ‘transition period’ means the first 24 months following the dates set out in Annex III for the placing on the market of Stage V engines;
- The applicable dates are:
 - 31st December, 2018: End of production of Transition engines.
 - 30th June 2020: Last date of production for machines incorporating Transition engines.
 - 31st December, 2020: End of placing on the market of machines incorporating Transition engines.
- For the transition engine, marking shall additionally include the engine production date in month and year (e.g. MM/YYYY), this marking may be a separate mark.

3.2 Engine Marking / EC Type Approval

- From 01.01.2019, engines shall be in conformity with Regulation (EU) 2016/1628 and be marked with the EC Type Approval number according to the format below, either by the certificate number A) or by a simplified mark B):
- Example for a lawnmower engine of variable speed and between 80 & 225 cc, the engine category is NRS and sub-category is NRS-vi-1a so the coding is SYA1.

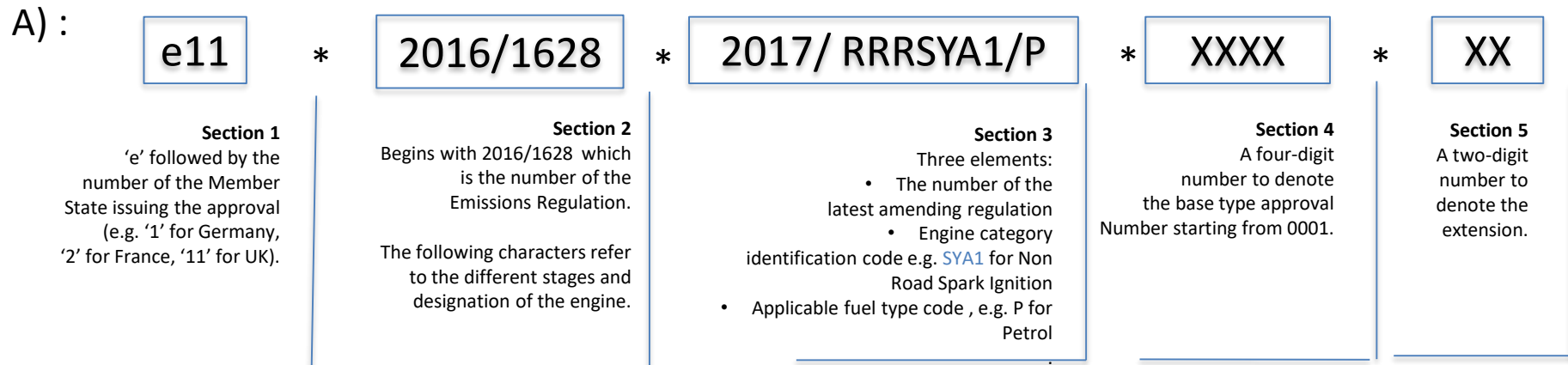

B) :

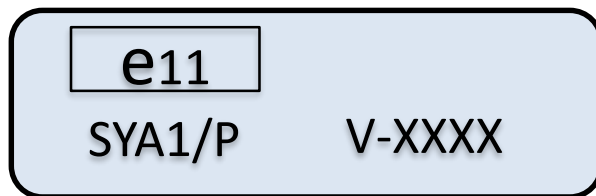

4. Marking / Outdoor Noise Label

Outdoor Noise Directive 2000/14/EC (as amended)

- The indication of the guaranteed sound power level must consist of:
 - the single number of the guaranteed sound power in dB
 - the sign L_{WA} and
 - a pictogram taking the following form:



Example

- Noise limits for walk behind lawnmowers by cutting width (L in cm):

$L \leq 50$	= 96 dB(A)
$50 < L \leq 70$	= 98 dB(A)
$70 < L \leq 120$	= 100 dB(A)
$L > 120$	= 105 dB(A)

5. Documentation / Instructions

Machinery Directive 2006/42/EC

For clarification, consult the European Commission Guide to application of the Machinery Directive 2006/42/EC



- Machinery must be accompanied by instructions in the official Community language(s) of the Member State in which it is made available
- The instructions must contain at least the following information:
 - business name and full address of the manufacturer and of his authorised representative (if the manufacturer is not located in an EU Member State)
 - descriptions and explanations necessary for safe use, adjustment and maintenance operations that should be carried out by the user, and preventive maintenance measures that should be taken
 - a description of the intended use of the machinery (professional use and use by consumers)
 - warnings concerning ways in which the machinery must not be used that experience has shown might occur.

6. Documentation / EU Declaration of Conformity

2006/42/EC, 2000/14/EC, 2014/30/EU

For clarification, consult the European Commission Guide to application of the Machinery Directive 2006/42/EC



The EU declaration of conformity must contain at least the following particulars:

- business name and full address of the manufacturer and, where appropriate, his authorised representative;
- name and address of the person authorised to compile the technical file, who must be established in the European Union;
- description and identification of the machinery including generic denomination, function, model, type, serial number and commercial name;
- a sentence expressly declaring that the machinery fulfils all the relevant provisions of this Directive and, where appropriate, a similar sentence declaring conformity with other Directives and/or relevant provisions with which the machinery complies;
- the name and address of the notified body which carried out the conformity assessment in accordance with the Outdoor Noise Directive 2000/14/EC;
- the guaranteed and measured sound power level in accordance with the Outdoor Noise Directive 2000/14/EC;
- the place and date of the declaration;
- the identity and signature of the person empowered to draw up the declaration on behalf of the manufacturer or his authorised representative.

7. Warning Text or Pictograms on the Machine*

- Read instructions

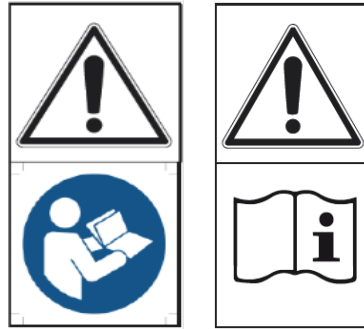

alternatives

- Keep bystanders away



- WARNING: Keep hands and feet away from the blades!



- * If pictograms are used, they must be explained in the instructions
- * If text is used, it must be in the official language(s) of the country where the product is sold